



Gary Outillage

Rue du Riant-Coteau 12

1196 Gland VD Suisse

Tel: 022 364 72 81

Fax: 022 364 35 83

Mobile: 079 473 91 21

http://www.gary-outillage.ch

PORTE OUTILS DIN 69880 (VDI 3425)

Porte-outils

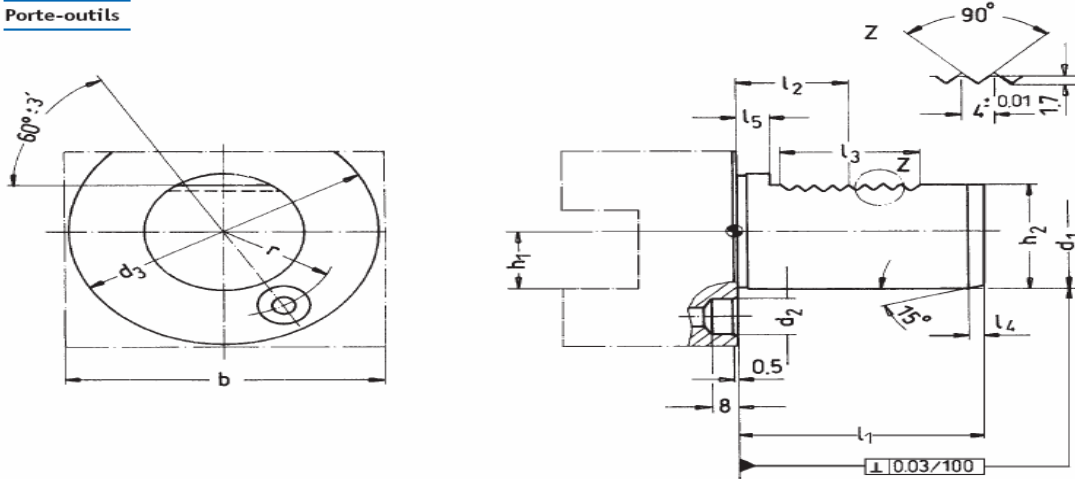

D1	h6	b	h1 max	d2	d3	h2 ± 0,1	r ± 0,02	l1 max.	l2 ± 0,05	l3 max.	l4 max.	l5
16	42	12	8	40	15,0	14,5	32	12,7	16	2	3,5	
20	52	16	10	50	18,0	18,0	40	21,7	24	2	7,0	
25	60	16	10	58	23,5	21,0	48	21,7	24	2	7,0	
30	70	20	14	68	27,0	25,0	55	29,7	40	2	7,0	
40	85	25	14	83	36,0	32,0	63	29,7	40	3	7,0	
50	100	32	16	98	45,0	37,0	78	35,7	48	3	8,0	

Exécution: Les porte-outils sont fabriqués en 16NC6, cémentés, trempés à HRC 60 ± 2 (HV 800 N/mm²), profondeur de trempé 0,8 mm ± 0,2 mm et entièrement brunis. La queue de fixation, la denture, la face d'appui et le logement de l'outil sont rectifiés. Tous les porte-outils ont une bille d'arrosage avec un grand angle d'orientation et un trou taraudé pour un arrosage par le centre.



Gary Outillage

Société de vente des outils de coupe

1196 Gland VD Suisse
 Tel: 022 364 72 81
 Fax: 022 364 35 83
 Mobile: 079 473 91 21
<http://www.gary-outillage.ch>

Porte-outil

DIN 69880 (VDI 3425)

Porte-outil radial forme B1 droit, court

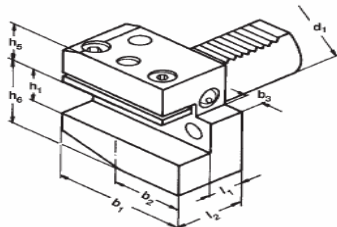

Référence	d1 × h1 × l2	l1	b1	b2	b3	h5	h6	Prix CHF
169.31.12	B1 – 16 × 12 × 24	13	42	23	5	20	22	79,40
209.31.16	B1 – 20 × 16 × 30	16	55	30	7	25	30	79,40
259.31.16	B1 – 25 × 16 × 30	16	55	30	7	25	30	79,40
309.31.20	B1 – 30 × 20 × 40	22	70	35	10	28	38	86,20
409.31.25	B1 – 40 × 25 × 44	22	85	42,5	12,5	32,5	48	98,00
509.31.32	B1 – 50 × 32 × 55	30	100	50	16	35	60	128,50

Porte-outil

DIN 69880 (VDI 3425)

Porte-outil radial forme B2 gauche, court

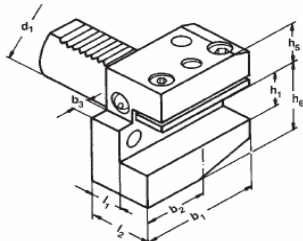

Référence	d1 × h1 × l2	l1	b1	b2	b3	h5	h6	Prix CHF
169.32.12	B2 – 16 × 12 × 24	13	42	23	5	20	22	79,40
209.32.16	B2 – 20 × 16 × 30	16	55	30	7	25	30	79,40
259.32.16	B2 – 25 × 16 × 30	16	55	30	7	25	30	79,40
309.32.20	B2 – 30 × 20 × 40	22	70	35	10	28	38	86,20
409.32.25	B2 – 40 × 25 × 44	22	85	42,5	12,5	32,5	48	98,00
509.32.32	B2 – 50 × 32 × 55	30	100	50	16	35	60	128,50

Porte-outil

DIN 69880 (VDI 3425)

Porte-outil radial forme B3 inversé droite, court

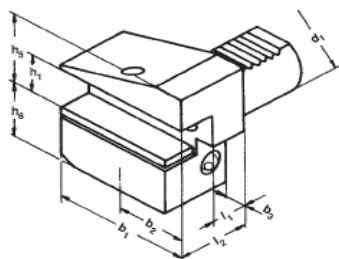

Référence	d1 × h1 × l2	l1	b1	b2	b3	h5	h6	Prix CHF
169.33.12	B3 – 16 × 12 × 24	13	42	23	5	22	20	79,50
209.33.16	B3 – 20 × 16 × 30	16	55	30	7	30	25	79,50
259.33.16	B3 – 25 × 16 × 30	16	55	30	7	30	25	89,60
309.33.20	B3 – 30 × 20 × 40	22	70	35	10	38	35	91,30
409.33.25	B3 – 40 × 25 × 44	22	85	42,5	12,5	48	42,5	104,80
509.33.32	B3 – 50 × 32 × 55	30	100	50	16	60	50	142,00

Accessoires: :retoise Nr. 5,18

Porte-outil

DIN 69880 (VDI 3425)

Porte-outil radial forme B4 inversé gauche, court

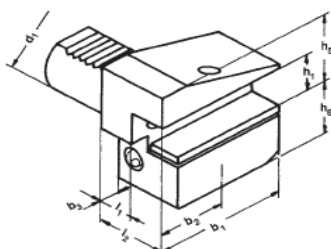

Référence	d1 × h1 × l2	l1	b1	b2	b3	h5	h6	Prix CHF
169.34.12	B4 – 16 × 12 × 24	13	42	23	5	22	20	79,50
209.34.16	B4 – 20 × 16 × 30	16	55	30	7	30	35	79,50
259.34.16	B4 – 25 × 16 × 30	16	55	30	7	30	35	89,60
309.34.20	B4 – 30 × 20 × 40	22	70	35	10	38	35	91,30
409.34.25	B4 – 40 × 25 × 44	22	85	42,5	12,5	48	42,5	104,80
509.34.32	B4 – 50 × 32 × 55	30	100	50	16	60	50	142,00

Accessoires: :retoise Nr. 5,18



Gary Outillage

Société de vente des outils de coupe

1196 Gland VD Suisse
 Tel: 022 364 72 81
 Fax: 022 364 35 83
 Mobile: 079 473 91 21
<http://www.gary-outillage.ch>

Porte-outil

DIN 69880 (VDI 3425)

Porte-outil axial forme C1 droite

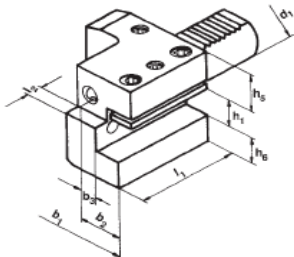

Référence	d1 × h1 b1	b2	b3	l1	l2	h5	h6		Prix CHF
169.41.12	C1 – 16 × 12	43	24	13	44	5	20	22	94,65
209.41.16	C1 – 20 × 16	52	27	13	50	7	25	30	99,70
259.41.16	C1 – 25 × 16	58	33	19	55	7	25	30	99,70
309.41.20	C1 – 30 × 20	70	35	17	70	10	28	38	101,40
409.41.25	C1 – 40 × 25	85	42	21	85	12,5	32,5	48	120,00
509.41.32	C1 – 50 × 32	100	50	26	100	16	35	60	150,40

Accessoires: :retoise Nr. 5,18

Porte-outil

DIN 69880 (VDI 3425)

Porte-outil axial forme C2 gauche

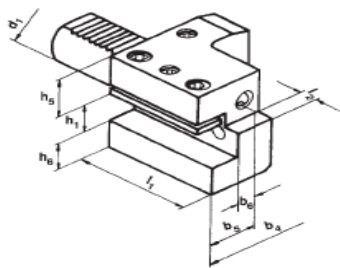

Référence	d1 × h1	b4	b5	b6	l1	l2	h5	h6	Prix CHF
169.42.12	C2 – 16 × 12	43	24	13	44	5	20	22	94,70
209.42.16	C2 – 20 × 16	65	40	26	50	7	25	30	99,80
259.42.16	C2 – 25 × 16	58	33	19	55	7	25	30	99,80
309.42.20	C2 – 30 × 20	76	41	23	70	10	28	38	101,40
409.42.25	C2 – 40 × 25	90	47,5	25,5	85	12,5	32,5	48	119,20
509.42.32	C2 – 50 × 32	105	55	30,5	100	16	35	60	150,40

Accessoires: :retoise Nr. 5,18

Porte-outil

DIN 69880 (VDI 3425)

Porte-outil axial forme C3 inversé droite, court

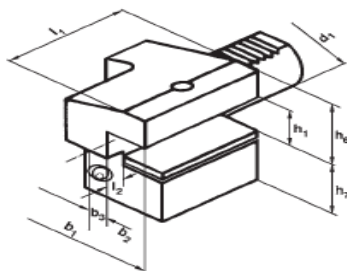

Référence	d1 × h1	b1	b2	b3	l1	l2	h6	h7	Prix CHF
169.43.12	C3 – 16 × 12	43	24	13	44	5	22	20	94,70
209.43.16	C3 – 20 × 16	52	27	13	50	7	30	25	99,80
259.43.16	C3 – 25 × 16	58	33	19	55	7	30	25	99,80
309.43.20	C3 – 30 × 20	70	35	17	70	10	38	35	116,70
409.43.25	C3 – 40 × 25	85	42,5	21	85	12,5	48	42,5	126,75
509.43.32	C3 – 50 × 32	100	50	26	100	16	60	50	150,40

Accessoires: :retoise Nr. 5,18

Porte-outil

DIN 69880 (VDI 3425)

Porte-outil axial forme C4 inversé gauche, court

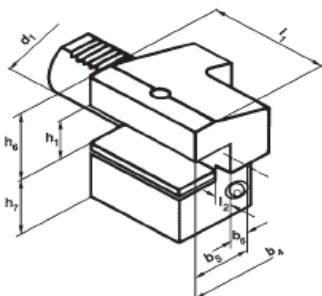

Référence	d1 × h1	b4	b5	b6	l1	l2	h6	h7	Prix CHF
169.44.12	C4 – 16 × 12	43	24	13	44	5	22	20	94,70
209.44.16	C4 – 20 × 16	65	40	26	50	7	30	25	99,80
259.44.16	C4 – 25 × 16	58	33	19	55	7	30	25	99,80
309.44.20	C4 – 30 × 20	76	41	23	70	10	38	35	116,70
409.44.25	C4 – 40 × 25	90	47,5	25,5	85	12,5	48	42,5	126,75
509.44.32	C4 – 50 × 32	105	55	30,5	100	16	60	50	150,40

Accessoires: :retoise Nr. 5,18



Gary Outillage

Société de vente des outils de coupe

1196 Gland VD Suisse
Tel: 022 364 72 81
Fax: 022 364 35 83
Mobile: 079 473 91 21
<http://www.gary-outillage.ch>

Porte-outil

DIN 69880 (VDI 3425)

Porte-outil forme E3 pour pinces de serrage DIN 6388

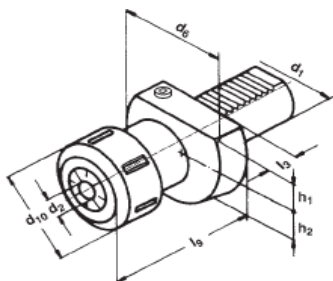

Référence	d1 x d2	d6	d10	h1	h2	l3	l9		Prix CHF
169.01.16	E3 - 16 x 2 - 16	40	43	18	18	13	45,5		143,65
209.01.16	E3 - 20 x 2 - 16	50	43	23	23	18	57		152,10
259.01.16	E3 - 25 x 2 - 16	58	43	25	25	18	57		152,10
309.01.16	E3 - 30 x 2 - 16	68	43	28	30	22	57		143,65
309.01.25	E3 - 30 x 2 - 25	68	60	28	30	22	75		143,65
409.01.25	E3 - 40 x 2 - 25	83	60	32,5	-	22	75		153,80
409.01.32	E3 - 40 x 3 - 32	83	72	32,5	-	22	90		153,80
509.01.25	E3 - 50 x 2 - 25	98	60	35	-	30	75		179,20
509.01.32	E3 - 50 x 3 - 32	98	72	35	-	30	90		187,60

Inclus: Ecrou de serrage

Accessoires: Pinces de serrage DIN 6388, forme B
Clé à ergot DIN 1810 A

Porte-outil

DIN 69880 (VDI 3425)

Porte-outils forme E4 pour pinces de serrage DIN 6499 Type ER

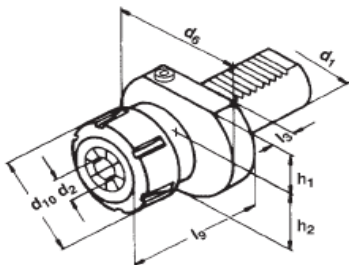

Référence	d1 x d2	d6	d10	h1	l3	l9		Prix CHF
169.02.10	E4 - 16 x ER16 1 - 10	40	32	18	13	50		119,20
209.02.10	E4 - 20 x ER16 1 - 10	50	32	22	16	55		119,20
209.02.16	E4 - 20 x ER25 2 - 16	50	42	22	16	57		119,20
259.02.16	E4 - 25 x ER25 2 - 16	58	42	24	18	57		119,20
309.02.16	E4 - 30 x ER25 2 - 16	68	42	28	22	57		123,40
309.02.20	E4 - 30 x ER32 2 - 20	68	50	28	22	75		123,40
309.02.26	E4 - 30 x ER40 3 - 26	68	63	28	22	75		123,40
409.02.16	E4 - 40 x ER25 2 - 16	83	42	32,5	22	75		128,40
409.02.20	E4 - 40 x ER32 2 - 20	83	50	32,5	22	75		128,40
409.02.26	E4 - 40 x ER40 3 - 26	83	63	32,5	22	75		128,40
509.02.26	E4 - 50 x ER40 3 - 26	98	63	35 3	30	75		179,20

Inclus: Ecrou de serrage

Accessoires: Pinces de serrage system ER
Clé de serrage ER



Gary Outillage

Société de vente des outils de coupe

1196 Gland VD Suisse
 Tel: 022 364 72 81
 Fax: 022 364 35 83
 Mobile: 079 473 91 21
<http://www.gary-outillage.ch>

Porte-outil

DIN 69880 (VDI 3425)

Porte foret pour foret à plaquettes réversibles forme E1

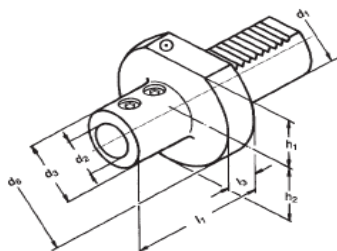

Référence	d1 x d2	d3	d6	h1	h2	l1	l2		Prix CHF
209.51.16	E1 – 20 x 16	40	50	22	22	67	16		98,00
209.51.20	E1 – 20 x 20	40	50	22	22	67	16		98,00
209.51.25	E1 – 20 x 25	45	50	22	22	71	16		98,00
259.51.16	E1 – 25 x 16	40	58	25	25	67	18		98,00
259.51.20	E1 – 25 x 20	40	58	25	25	67	18		98,00
259.51.25	E1 – 25 x 25	45	58	25	25	71	18		98,00
309.51.16	E1 – 30 x 16	36	68	28	30	64	22		103,10
309.51.20	E1 – 30 x 20	40	68	28	30	67	22		103,10
309.51.25	E1 – 30 x 25	45	68	28	30	71	22		103,10
309.51.32	E1 – 30 x 32	52	68	28	30	75	22		103,10
309.51.40	E1 – 30 x 40	60	68	28	30	95	22		103,10
409.51.16	E1 – 40 x 16	36	83	32,5	–	64	22		108,20
409.51.20	E1 – 40 x 20	40	83	32,5	–	67	22		108,20
409.51.25	E1 – 40 x 25	45	83	32,5	–	75	22		108,20
409.51.32	E1 – 40 x 32	52	83	32,5	–	75	22		108,20
409.51.40	E1 – 40 x 40	60	83	32,5	–	90	22		108,20
509.51.16	E1 – 50 x 16	40	98	35	–	66	30		143,65
509.51.20	E1 – 50 x 20	40	98	35	–	66	30		143,65
509.51.25	E1 – 50 x 25	45	98	35	–	80	30		143,65
509.51.32	E1 – 50 x 32	52	98	35	–	80	30		143,65
509.51.40	E1 – 50 x 40	65	98	35	–	90	30		143,65
509.51.50	E1 – 50 x 50	75	98	35	–	100	30		143,65

Porte-outil

DIN 69880 (VDI 3425)

Arbre pour mandrin de perçage
 DIN 238

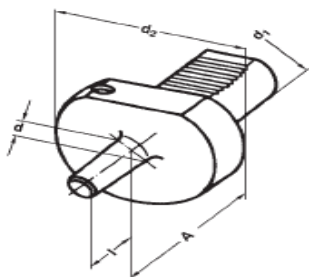

Référence	d1 x d		d2		A		l		Prix CHF
309.14.016	30 x B16		68		27		24		82,80
409.14.016	40 x B16		83		27		24		87,90
509.14.016	50 x B16		98		35		24		110,00

Accessoires: Mandrin de perçage



Gary Outillage

Société de vente des outils de coupe

1196 Gland VD Suisse

Tel: 022 364 72 81

Fax: 022 364 35 83

Mobile: 079 473 91 21

<http://www.gary-outillage.ch>

Porte-outil **DIN 69880 (VDI 3425)**

Porte-outil pour barre d'alésage
forme E2

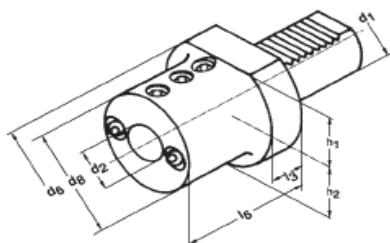

Accessoires:

Douilles de réduction

Référence	d1 x d2	d6	d8	h1	h2	l3	l6	Prix CHF
169.52.06	E2 - 16 x 06	40	32	18	18	13	44	94,70
169.52.08	E2 - 16 x 08	40	32	18	18	13	44	94,70
169.52.10	E2 - 16 x 10	40	32	18	18	13	44	94,70
169.52.12	E2 - 16 x 12	40	40	18	18	13	44	94,70
169.52.16	E2 - 16 x 16	40	40	18	18	13	44	94,70
209.52.08	E2 - 20 x 08	50	40	-	23	18	50	94,70
209.52.10	E2 - 20 x 10	50	40	-	23	18	50	94,70
209.52.12	E2 - 20 x 12	50	40	-	23	18	50	94,70
209.52.16	E2 - 20 x 16	50	40	-	23	18	50	94,70
209.52.20	E2 - 20 x 20	50	50	-	23	18	50	94,70
209.52.25	E2 - 20 x 25	50	50	-	23	18	60	94,70
259.52.08	E2 - 25 x 08	58	40	25	25	18	50	94,70
259.52.10	E2 - 25 x 10	58	40	25	25	18	50	94,70
259.52.12	E2 - 25 x 12	58	40	25	25	18	50	94,70
259.52.16	E2 - 25 x 16	58	40	25	25	18	50	94,70
259.52.20	E2 - 25 x 20	58	58	25	25	18	50	94,70
259.52.25	E2 - 25 x 25	58	58	25	25	18	60	94,70
309.52.08	E2 - 30 x 08	68	55	28	30	22	60	94,70
309.52.10	E2 - 30 x 10	68	55	28	30	22	60	94,70
309.52.12	E2 - 30 x 12	68	55	28	30	22	60	94,70
309.52.16	E2 - 30 x 16	68	55	28	30	22	60	94,70
309.52.20	E2 - 30 x 20	68	55	28	30	22	60	94,70
309.52.25	E2 - 30 x 25	68	55	28	30	22	60	94,70
309.52.32	E2 - 30 x 32	68	68	28	30	22	75	94,70
409.52.08	E2 - 40 x 08	83	55	32,5	-	22	75	98,00
409.52.10	E2 - 40 x 10	83	55	32,5	-	22	75	98,00
409.52.12	E2 - 40 x 12	83	55	32,5	-	22	75	98,00
409.52.16	E2 - 40 x 16	83	55	32,5	-	22	75	98,00
409.52.20	E2 - 40 x 20	83	55	32,5	-	22	75	98,00
409.52.25	E2 - 40 x 25	83	55	32,5	-	22	75	98,00
409.52.32	E2 - 40 x 32	83	83	32,5	-	22	75	98,00
409.52.40	E2 - 40 x 40	83	83	32,5	-	22	90	98,00
509.52.12	E2 - 50 x 12	98	68	35	-	30	90	135,20
509.52.16	E2 - 50 x 16	98	68	35	-	30	90	135,20
509.52.20	E2 - 50 x 20	98	68	35	-	30	90	135,20
509.52.25	E2 - 50 x 25	98	68	35	-	30	90	135,20
509.52.32	E2 - 50 x 32	98	68	35	-	30	90	135,20
509.52.40	E2 - 50 x 40	98	98	35	-	30	90	135,20
509.52.50	E2 - 50 x 50	98	98	35	-	30	100	135,20



Gary Outillage

Société de vente des outils de coupe

1196 Gland VD Suisse
 Tel: 022 364 72 81
 Fax: 022 364 35 83
 Mobile: 079 473 91 21
<http://www.gary-outillage.ch>

Porte-outil

DIN 69880 (VDI 3425)

Douilles de réduction pour barres d'alésage

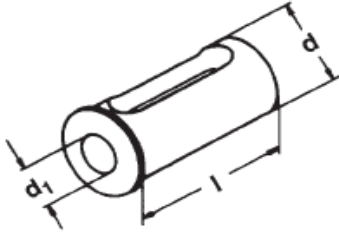

Référence	d			d1			l		Prix CHF
709.25.06	25			6			50		47,35
709.25.08	25			8			50		47,35
709.25.10	25			10			50		47,35
709.25.12	25			12			50		47,35
709.25.16	25			16			50		47,35
709.25.20	25			20			50		47,35
709.32.06	32			6			70		50,70
709.32.08	32			8			70		50,70
709.32.10	32			10			70		50,70
709.32.12	32			12			70		50,70
709.32.16	32			16			70		50,70
709.32.20	32			20			70		50,70
709.32.25	32			25			70		50,70
709.40.06	40			6			80		54,10
709.40.08	40			8			80		54,10
709.40.10	40			10			80		54,10
709.40.12	40			12			80		54,10
709.40.16	40			16			80		54,10
709.40.20	40			20			80		54,10
709.40.25	40			25			80		54,10
709.40.32	40			32			80		54,10

Porte-outil

DIN 69880 (VDI 3425)

Porte-foret pour outil à cône Morse forme F1

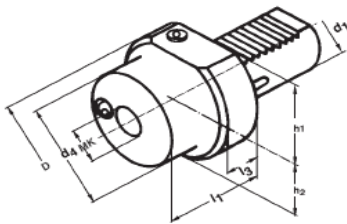

Référence	d1 x MK	d4	D	l1	l3	h1	h2		Prix CHF
169.07.01	F1 16 x MK1	32	40	32	13	18	18		103,10
209.07.01	F1 20 x MK1	-	50	23	-	22	23		103,10
209.07.02	F1 20 x MK2	40	50	90	30	22	23		103,10
259.07.01	F1 25 x MK1	-	58	23	-	25	25		103,10
259.07.02	F1 25 x MK2	-	58	27	-	25	25		103,10
309.07.01	F1 30 x MK1	-	68	27	-	28	30		103,10
309.07.02	F1 30 x MK2	-	68	27	-	28	30		103,10
309.07.03	F1 30 x MK3	58	68	40	22	28	30		103,10
409.07.02	F1 40 x MK2	55	83	36	22	32,5	-		108,20
409.07.03	F1 40 x MK3	55	83	36	22	32,5	-		108,20
409.07.04	F1 40 x MK4	68	83	80	22	32,5	-		108,20
509.07.02	F1 50 x MK2	55	98	36	30	35	-		135,20
509.07.03	F1 50 x MK3	58	98	36	30	35	-		135,20
509.07.04	F1 50 x MK4	68	98	50	30	35	-		135,20
509.07.05	F1 50 x MK5	75	98	72	30	35	-		169,00



Gary Outillage

Société de vente des outils de coupe

1196 Gland VD Suisse
 Tel: 022 364 72 81
 Fax: 022 364 35 83
 Mobile: 079 473 91 21
<http://www.gary-outillage.ch>

Porte-outil **DIN 69880 (VDI 3425)**

Mandrin de perçage CNC avec rotation gauche-droite et arrosage par le centre

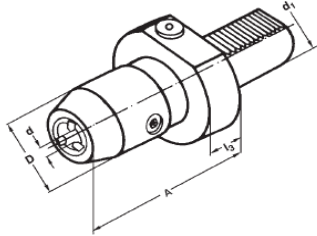

Système de tête WTE

Référence	d1	d Capacité	A	D	I3	Prix CHF
209.15.08	20	0,5 – 8	68	36	18	456,30
209.15.13	20	1 – 13	90	50	18	456,30
259.15.13	25	1 – 13	90	50	18	456,30
309.15.13	30	1 – 13	90	50	22	456,30
309.15.16	30	3 – 16	90	57	22	471,00
409.15.13	40	1 – 13	90	50	22	471,00
409.15.16	40	3 – 16	90	57	22	486,70
509.15.16	50	3 – 16	90	57	30	527,30

Porte-outil **DIN 69880 (VDI 3425)**

Mandrin de perçage CNC avec rotation gauche-droite et arrosage buses de picot

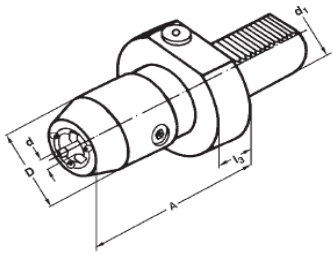

Référence	d1	d Capacité	A	D	I3	Prix CHF
309.15.13.K	30	1 – 13	80	44	22	510,40
309.15.16.K	30	1,5 – 16	87,5	49	22	554,40
409.15.13.K	40	1 – 13	80	44	22	520,60
409.15.16.K	40	1,5 – 16	87,5	49	22	554,40

Porte-outil **DIN 69880 (VDI 3425)**

Appareil à tarauder avec compensation longitudinale

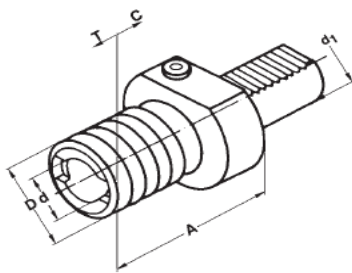

Référence	d1	Capacité	A	D	d	C	T	Prix CHF
209.16.12	20	M3 / M14	55	38	19	7	7	422,50
259.16.12	25	M3 / M14	55	38	19	7	7	422,50
309.16.12	30	M3 / M14	55	38	19	7	7	358,30
309.16.20	30	M5 / M22	77	54	31	12	12	417,50
409.16.12	40	M3 / M14	55	38	19	7	7	358,30
409.16.20	40	M5 / M22	77	54	31	12	12	417,50
509.16.12	50	M3 / M14	55	38	19	7	7	544,20
509.16.20	50	M5 / M22	77	54	31	12	12	611,80

Version comprenant douille de glissière à bille

Porte-outil **DIN 69880 (VDI 3425)**

Appareil à tarauder sans compensation longitudinale

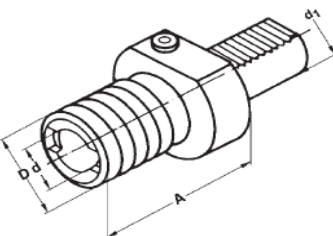

Référence	d1	Capacité	A	D	d	Prix CHF
209.16.12.1	20	M3 / M14	55	38	19	
259.16.12.1	25	M3 / M14	55	38	19	
309.16.12.1	30	M3 / M14	55	38	19	275,50
309.16.20.1	30	M5 / M22	77	54	31	290,70
409.16.12.1	40	M3 / M14	55	38	19	275,50
409.16.20.1	40	M5 / M22	77	54	31	290,70
509.16.12.1	50	M3 / M14	55	38	19	
509.16.20.1	50	M5 / M22	77	54	31	



Gary Outillage

Société de vente des outils de coupe

1196 Gland VD Suisse
Tel: 022 364 72 81
Fax: 022 364 35 83
Mobile: 079 473 91 21
<http://www.gary-outillage.ch>

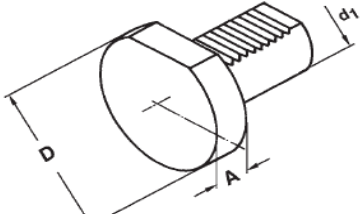
Porte-outil		DIN 69880 (VDI 3425)						
Bouchon de protection 	Référence	d1			A	D		Prix CHF
	169.29.13	16 x 13			13	40		30,50
	209.29.16	20 x 16			16	50		30,50
	259.29.16	25 x 16			16	58		30,50
	309.29.20	30 x 20			20	68		30,50
	409.29.20	40 x 20			20	83		35,50
	509.29.20	50 x 20			20	98		47,40

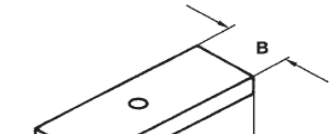
Porte-outil		DIN 69880 (VDI 3425)						
Plaque entretoise 	Référence	Dimension					Prix CHF	
	209.16.01	14 x 4 x 54					11,90	
	309.20.01	18 x 4 x 69					10,15	
	409.25.01	22 x 5 x 84					10,15	
	509.32.01	25 x 7 x 99					11,90	